

Sentinel

Ultra Compact, 4CH, H.264,
Split-Type Camera System

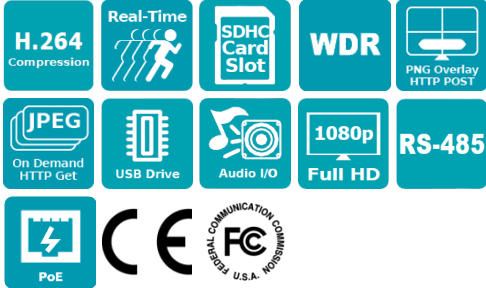

Features

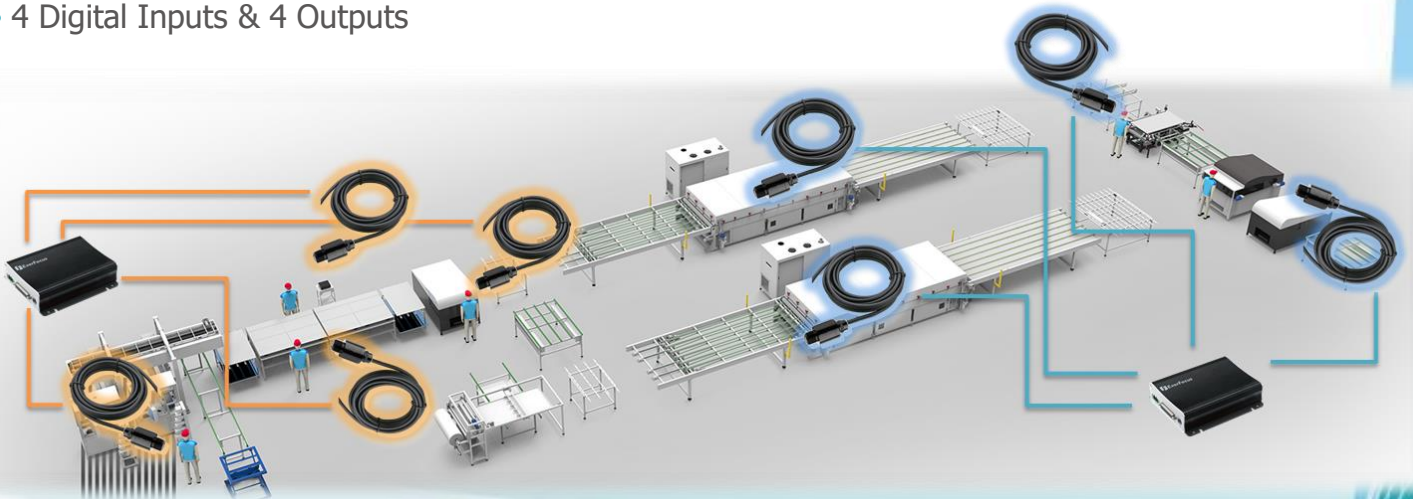

- Ultra Compact Size for easy installation
- 4 channels of Real-Time 1080p Video and Audio Recording
- Recording Rate: up to 30(25)fps/ch @1080p resolution
- H.264 Format for efficient storage and network utilization
- eZ.Controller function: Control camera OSD settings directly from Sentinel Video Recorder
- D-sub Connectors for shock & vibration resistance
- Plug-and-play recording on the completely shock proof SDHC / SDXC card (up to 128GB per card)
- Archives recordings to the USB storage device
- Wide Dynamic Range function (WDR) via Camera OSD
- Two-Way Audio
- Easy JPEG Images On-Demand via HTTP command (HTTP GET)
- Pop-up Text / Image on local display via HTTP command (HTTP POST)
- Water-resistant design for video input connectors
- Video and power transferred through mini DIN cable
- Supports Multiple Interfaces
- Double Power Inputs supported: PoE and 12VDC
- 4 Digital Inputs & 4 Outputs

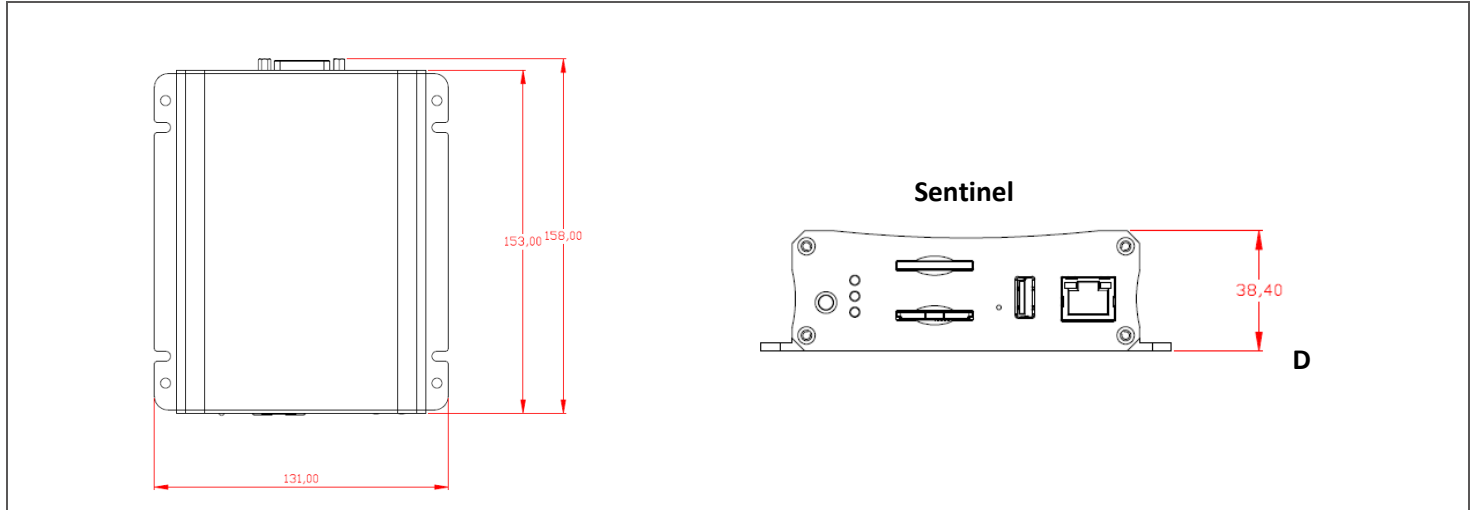

Dimensions



Ordering Options

Camera Type	
<p>Sentinel 2</p> <p>Sentinel Unit, 4 x Camera, 2.7mm, Sony sensor, 1080p, 3m cable, Mini DIN</p> 	<p>Sentinel 8</p> <p>Sentinel Unit, 4 x Camera, 8mm, Sony sensor, 1080p, 3m cable, Mini Din, Focus Adjustable</p> 

Camera Extension Cable

MEC-009

Sentinel System Extension Cable – 9m / 30 ft

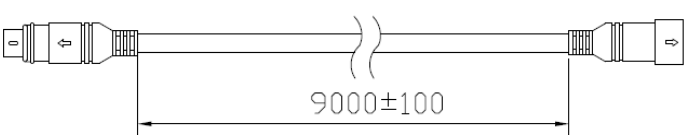

The drawing shows a long, thin cable with connectors at both ends. A dimension line below the cable indicates a length of 9000±100.

PoE Switch

EverFocus 5 / 8 / 16 / 24 Ports PoE Switch



- 5 Ports: ES0501-40
- 8 Ports: ES0812-31 / ES0802-41
- 16 Ports: ES1625-31 / ES1645-51
- 24 Ports: ES2426-31 / ES2446-51 / ES2448-62

Specification

Model No.		Sentinel - ESN41 FHD	
Video Input	Number of Channels	4CH mini DIN	
	Video Compression	H.264	
Audio	Audio Inputs	4	
	Audio Output	RCA x 1	
Video Output	Video Output (Main Monitor)	VGA x 1	
	Video Output (Call Monitor)	BNC x 1	
Recording	Recording Resolution	1080p / 720p / 960H / D1 / CIF / QCIF	
	Recording Mode	Event, Normal + Event, Schedule	
	Recording Rate	30fps/CH (NTSC), 25fps/CH (PAL)	
	Pre-Alarm Recording	Yes	
Playback	Playback Mode	Duplex	
	Playback Search	Time Search, Event Search	
Video Detection & Alarm	Alarm Inputs	4	
	Alarm Outputs	4	
	Video Loss Detection	Yes	
	Event Alarm	Yes	
Network	Ethernet	RJ-45 Port x 1 (10/100/1000M)	
Storage	SD Card	SDHC / SDXC Slot x 2 (max. 128GB per card)	
External Interface	Interfaces	RJ-45 x 1, USB2.0 x 1, External I/O Port x 1, RS-485	
General	System Control	IR Remote Control, Mouse, Web UI	
	PTZ Control	Yes	
	Power Source	PoE / 12VDC	
	Power Consumption	PoE 27W / 12VDC 30W	
	Operating Temperature	-40°C ~ 55°C / -40°F ~ 131°F	
	Dimensions (W x D x H)	131 x 158 x 38.4mm / 5.16" x 6.22" x 1.51"	
	Weight	650g / 1.43lb	
	Certificates	CE, FCC, E-Mark	

*All images presented in this document are for example only. Product models may vary in different countries. Please visit EverFocus regional Websites for detailed ordering information.

*Information contained in this document is subject to change without notice.

Find Out More At:

EverFocus Taiwan HQ:

TEL: +886 2 2698 2334
www.everfocus.com.tw
marketing@everfocus.com.tw

EverFocus USA - California:

TEL: +1 626 844 8888
www.everfocus.com
sales@everfocus.com

International Branch Offices:

Germany, China, Japan

